



RESCO®

1098/1

MAN

TESTE PER TELAIO PORTE.

Heads for door frame.
Tête pour chassis de portes.
Tuerrahmenkopf.
Cabeza para marco puertas.

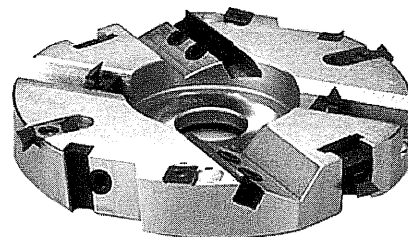

D	H	d max	Z	V	Rsr	g	C.P.
200	30	50	2+2	2	2+2	2	D31

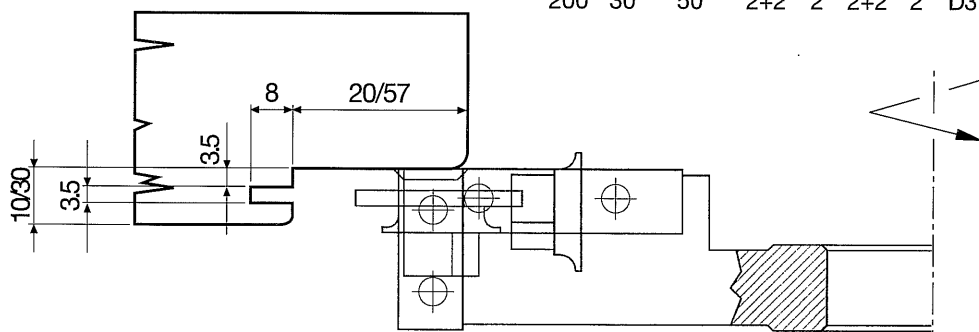
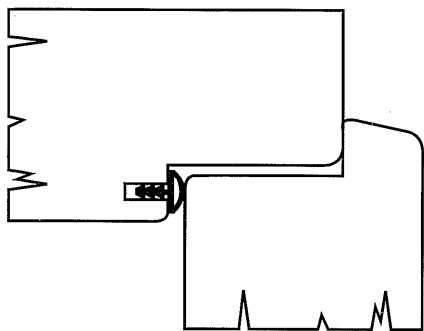

Cod. 6.000.011

Cod. 6.000.017

Cod. 6.000.200

Cod. 6.060.280

Cod. 6.100.151

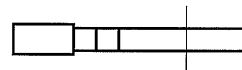
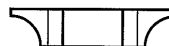
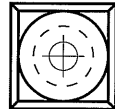
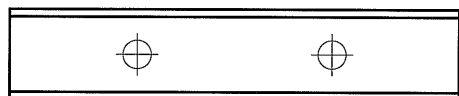
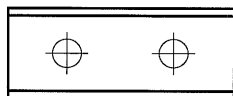

1100

MEC

TESTE PER GIUNZIONI DI LISTELLI PER PORTE.

Heads for door's jointing seats.
Têtes pour l'assemblage des moulures des portes.
Fräsen für Verbindungen von Türleisten.
Cabezas para juntas de listones de puertas.

	D	H	d max	Z	V	C.P.
A	136	15	50	2	-	
B	134	30	50	2	2	
C	134	30	50	2	2	
D	136	15	50	2	-	

Cod. 6.333.100

H36

Ricambi C.P.

R.1100 A D3

R.1100 B D3

