

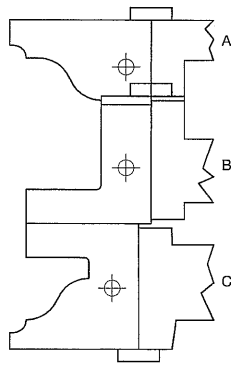

**RESCO®**

**1177**

**MAN**

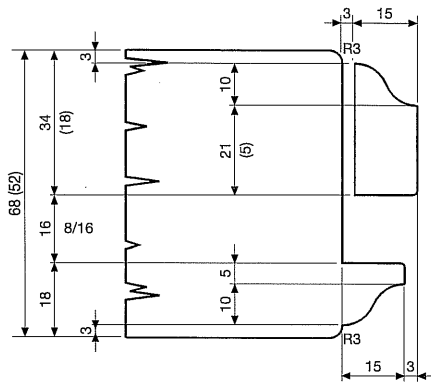
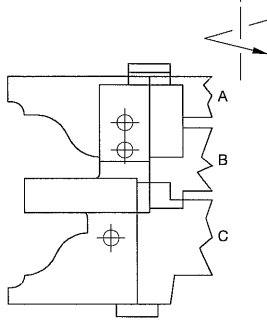
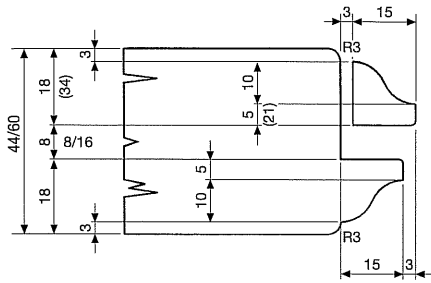

D H d max Z C.P.

A	170	20	50	2
B	162	30	50	2
C	170	30	50	2

Cod. 6.333.100

C35

Ricambi C.P.

R.1177/A1	B4
R.1177/B	M4
R.1177/C1	M4
R.1177/A2	B4
R.1177/C2	M4
R.1177/A3	B4
R.1177/C3	M4
R.1177/A4	B4
R.1177/C4	M4
R.1177/A5	B4
R.1177/C5	M4
R.1177/A6	B4
R.1177/C6	M4
R.1177/A7	B4
R.1177/C7	M4
R.1177/A8	B4
R.1177/C8	M4
R.1177/A9	B4
R.1177/C9	M4

Set standard fornito con profilo 1. Altri profili a richiesta

**1178**

**MAN**

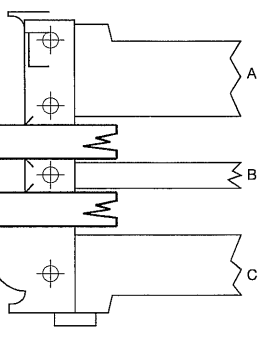
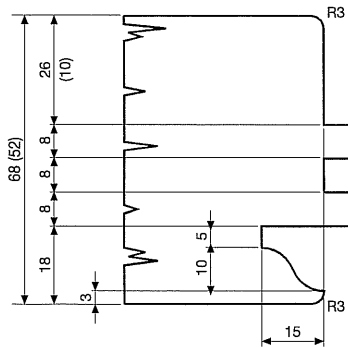
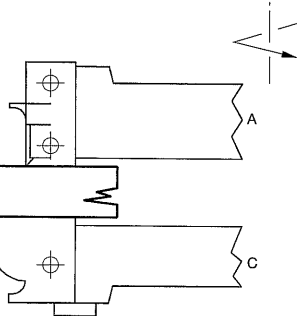
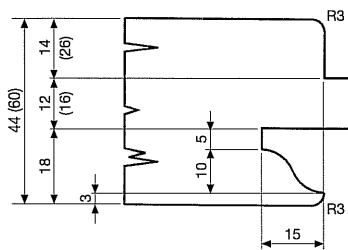

D H d max Z V Rs C.P.

A	254	25	50	4	2	2	H24
B	254	8	50	4	2+2	-	E22
C	284	20	50	4	-	-	C25

Cod. 6.333.100

M13

G36

Ricambi C.P.

R.1178/C1	A4
R.1178/C2	A4
R.1178/C3	A4
R.1178/C4	A4
R.1178/C5	A4
R.1178/C6	A4
R.1178/C7	A4
R.1178/C8	A4
R.1178/C9	A4

Set standard fornito con profilo 1. Altri profili a richiesta

R.1177/A1

R.1177/B

R.1177/C1

R.1178/C1

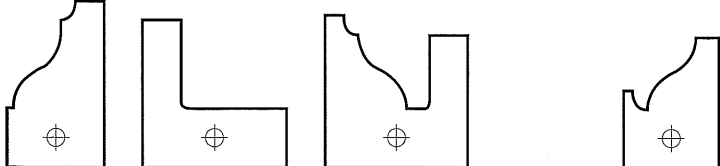

Cad. set profili composto da:

n. 2 R.1177/A	C.P.
n. 2 R.1177/C	
n. 4 R.1178/C	

F18

ESEMPI DI PROFILI:

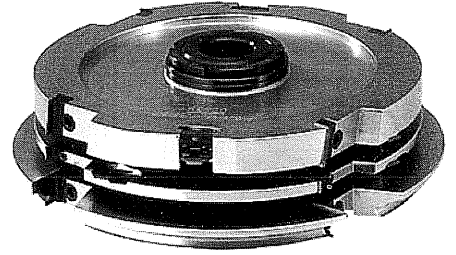
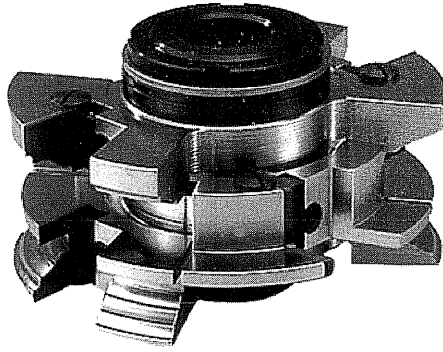

PROF. 1

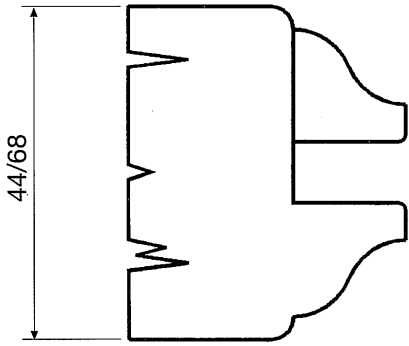

PROF. 2

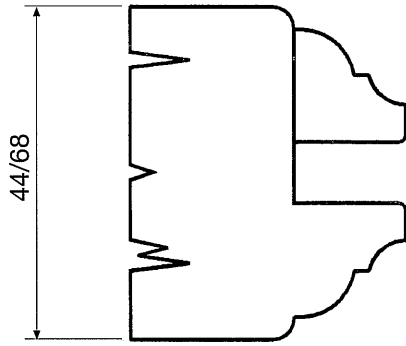

PROF. 3

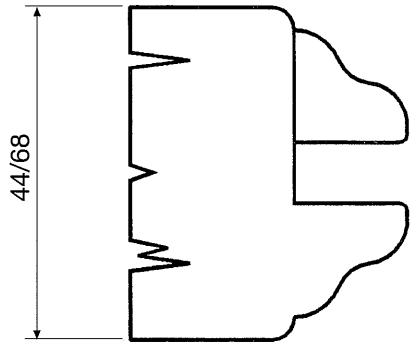

PROF. 4

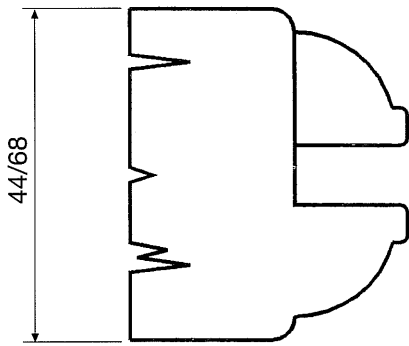

PROF. 5

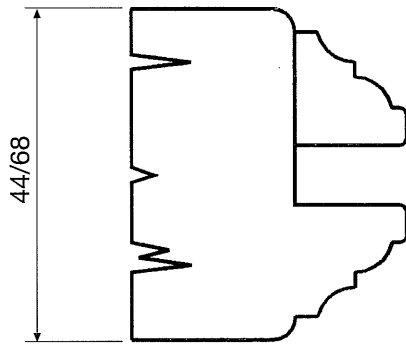

PROF. 6

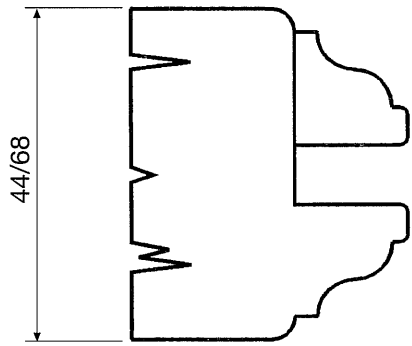

PROF. 7

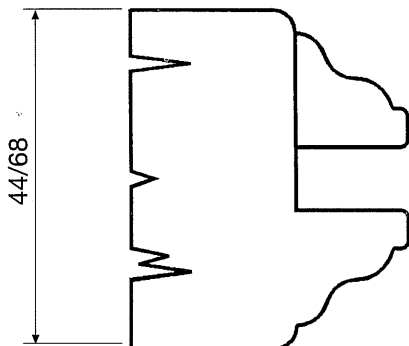

PROF. 8

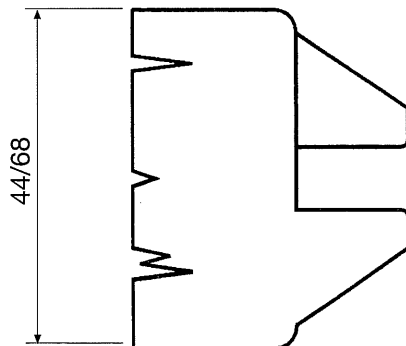

PROF. 9

