



RESCO®

TESTA PER GIUNZIONI A 45°.

45° jointing head.

Tête pour assemblages a 45°.

45° - Verbindungs - Köpf.

Cabeza para ensambladuras de 45°.

1092/2

MAN

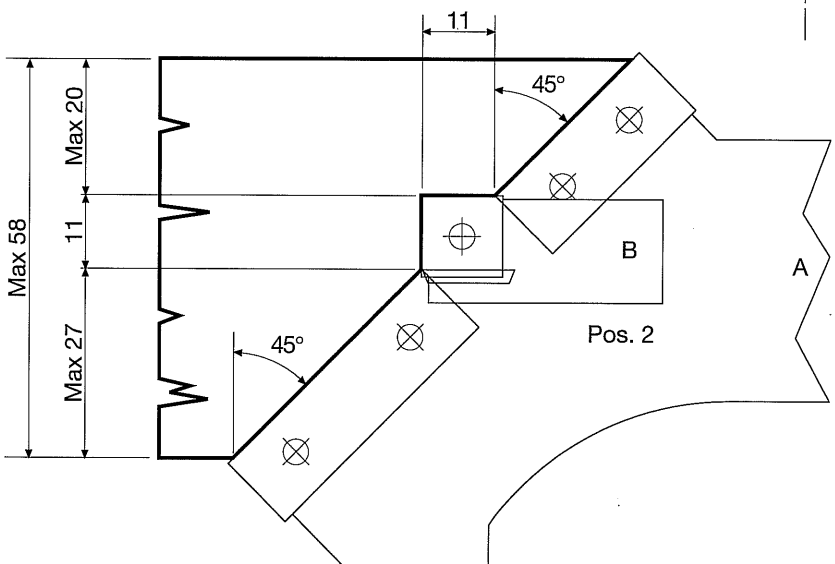
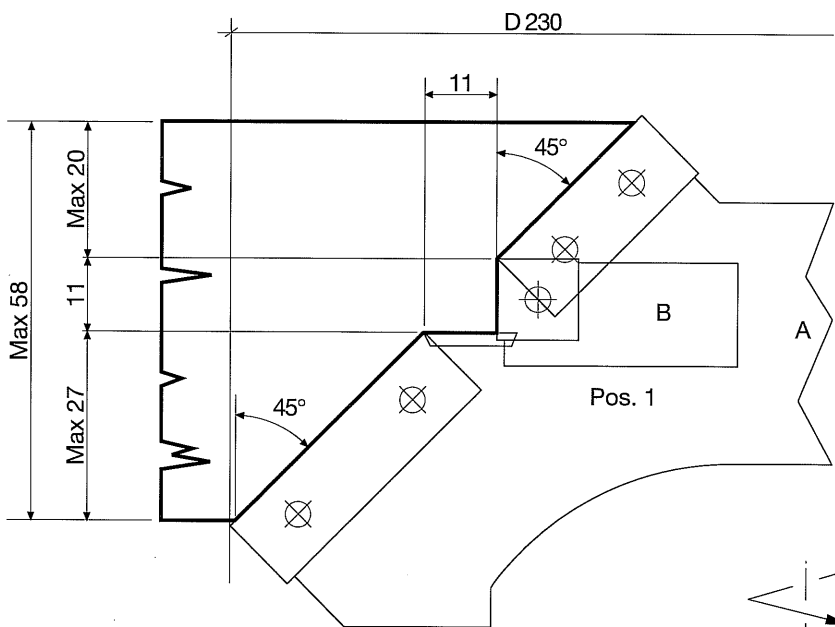
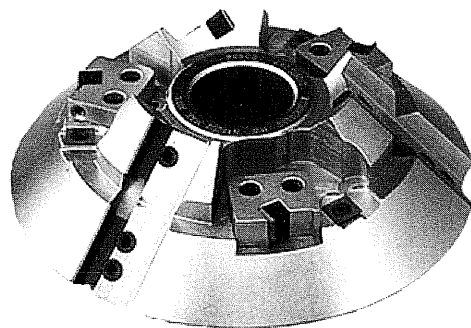

D	H	d max	Z	V	C.P.
230	76	50	3+3+3	3	C31

Supporto portacoltelli	C.P.
RS.1092/2	H5

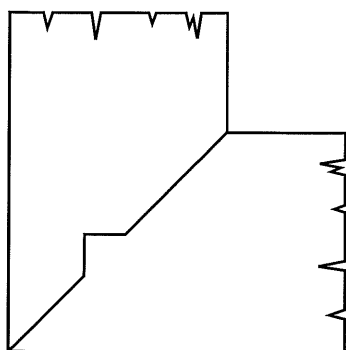

Cod. 6.000.005



Cod. 6.000.011

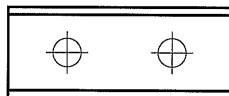

Cod. 6.000.013

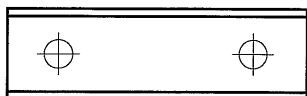

Cod. 6.000.200

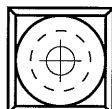

RS 1092/2

